

INON

INON Strobe Light Holder LF

Thank you for purchasing INON product.

INON Strobe Light Holder LF holds 『1』 or 『2』 INON LF series LED flashlight (『LF1000-S』etc.) and 『single』 INON strobe (『S-2000』, 『D-2000』, 『Z-240』etc.) on the compatible strobe arm/lighting arm supporting multiple light source lighting with simple arm configuration. Usable as holder to hold LF series LED flashlight only as well.

Optional 『Z Adapter II』/『Z Joint』 or 『Z Adapter』 etc. is necessary to use this product. Please prepare either of them according to your intended usage.

- Package contents:**
- Strobe Light Holder Body ① ×1
 - LF Light Holder Plate ② ×2
 - M4x8 Low Head Cap Screw ③ ×8
 - Strobe Light Holder Thumb Knob Screw ④ ×1
 - Strobe Light Holder Cap Screw ⑤ ×1
 - Strobe Light Holder M6 Screw ⑥ ×1
 - Allen Wrench (AF:2.5mm) ⑦ ×1
 - Allen Wrench (AF:5mm) ⑧ ×1
 - This user manual ×1

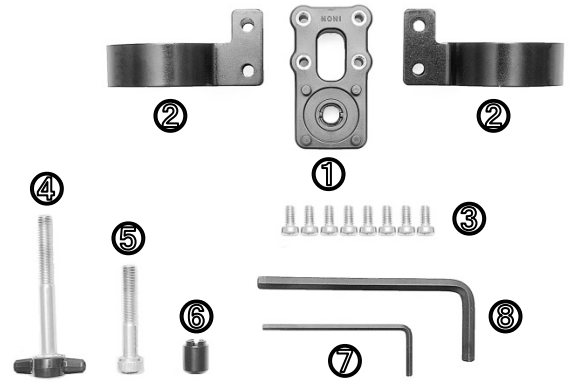

- Compatible LED flashlight :**
- INON 『LF1000-S』
 - INON 『LF1400-S』
 - INON 『LF1100-W』
 - INON 『LF800-N』(*1)
 - INON 『LF2700-W』
- (As of February 2015)**

(*1) Compatible only when combined with S-2000 strobe. (Refer to compatible strobe section)

- Max. number of LED flashlight :**
- When combined with 『Z Adapter II』 × × × Maximum two LF series LED flashlights
 - When combined with 『Z Joint』 × × × Maximum one LF series LED flashlight
 - When combined with 『Z Adapter』 × × × Maximum two LF series LED flashlights
- (As of February 2015)**

- Compatible Strobe :**
- INON 『S-2000』, 『Z-240』
 - INON 『D-2000』, 『D-2000S』, 『D-2000W/Wn』
 - INON 『D-180』(*3), 『D-180S』
 - INON 『Z-220F』, 『Z-220S』(*3), 『Z-220』(*3)
- (*2)(*4)**
- (As of February 2015)**

(*2) Wireless Connection is not usable when installing a strobe on this product. Use “Optical D Cable” product or sync cable.

(*3) For 『D-180』/『Z-220』/『Z-220S』, there are two Arm Base design depending on production lot and only trapezoidal version can accept this product.

(*4) 『LF800-N』 can be combined only with 『S-2000』 strobe via this product. (Any other INON strobe like 『D-2000』 『Z-240』 etc. cannot be combined with 『LF800-N』)

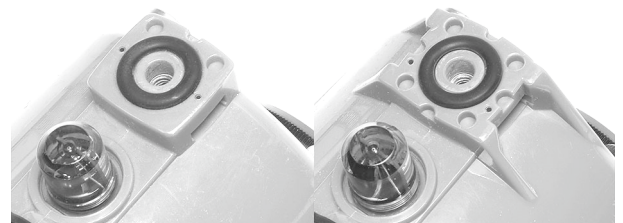

Not compatible

Compatible

- Compatible arm :** When using optional 『Z Adapter II』/『Z Adapter』
- INON “Arm II System”, “Float Arm System”
- (As of February 2015)**

“『YS Adapter』compatible arm” listed below via optional 『Z Joint』

- INON 『Shoe Base』, 『Bar Mount』, 『Grip Base D4』, 『Grip Base M1』, 『D Holder』, 『D Holder Extension Bar』
- INON 『YS Adapter MV』, 『Double YS Adapter MV』, 『YS Adapter WB MV』, 『YS Adapter』, 『YS Arm MS』, 『YS Arm M』
- INON 『Port Arm for MRS』, 『Port Arm for UFL-MR130 EFS60』

Installation method: Attaching LED flashlight

Firstly separate “Light Head” and “Battery Box” of your LF series LED flashlight and remove total three O-rings; two yellow O-rings and one black O-ring from the “Battery Box”.

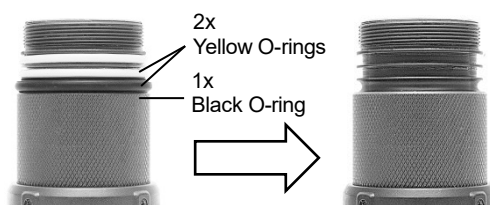

(continued)

Widen the mouth of the 「LF Light Holder Plate」 to attach it on the “Battery Box” then re-install removed three O-rings on the “Battery Box” and attach the “Light Head” on “Battery Box”. When removing/attaching “Light Head”/“Battery Box” O-rings, make sure to refer to your LED flashlight user manual to ensure proper and appropriate procedure. Put INON grease in 「screw holes」 on the 「Strobe Light Holder Body」 and joint the 「Strobe Light Holder Body」 and the 「LF Light Holder Plates」 together with supplied screws as in below image. You can attach one LED flashlight on either side or two flashlights when using 「Z adapter II」 / 「Z Adapter」 while using 「Z Joint」 allows to hold one flashlight on either side. (Refer to 「Z Adapter II/Z Joint/Z Adapter Installation」 section below)



Z Adapter II/Z Joint/Z Adapter Preparation

When using Z Adapter II, remove pre-installed 「Washer(white)」 from 「M6 thumbscrew」 and replace the screw with supplied 「Strobe Light Holder Cap Screw」 then attach it and the 「Washer(white)」 on the Z Adapter II. Make sure that 「Z Adapter II」 already has 3 sets of 「M2 Cap Bolt」.

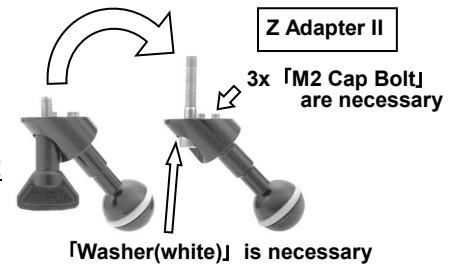

When using Z Joint, replace pre-installed 「Cap Screw」 on the Z Joint with supplied 「Strobe Light Holder Cap Screw」.

When using Z Adapter, remove pre-installed 「Spacer」 from 「Fixing Screw (black)」 and replace the screw with supplied 「Strobe Light Holder Thumb Knob Screw」 then attach it and the 「Spacer」 on the Z Adapter.

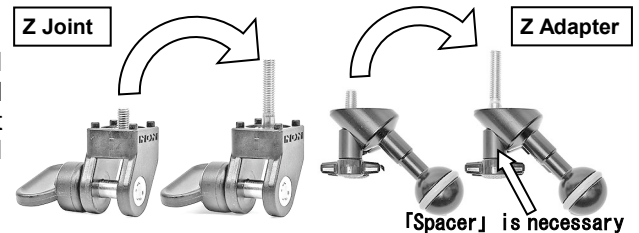

DO NOT use any other combination specified above to avoid possible damage on strobe body case.

Z Adapter II/Z Joint/Z Adapter Installation

Set the Z Adapter II/Z Joint/Z Adapter with replaced screw on the 「Strobe Light Holder Body」 so that the O-ring on the 「Strobe Light Holder Body」 contacts with the Z Adapter II/Z Joint/Z Adapter. Then screw them properly on compatible strobe arm base in accordance with below.

- When using the Z Adapter II, be sure to use pre-installed 「Washer(white)」 / 3 sets of 「M2 Cap Bolt」 comes with the Z Adapter II and the 「Strobe Light Holder Cap Screw」 comes with this product, then fix on combined strobe with the Allen Wrench (AF:5mm) using long side of the wrench not to apply excessive torque. Applying excessive torque like using short side of the wrench may damage on the combined strobe.
- When using the Z Joint, make sure to combine it with correct orientation where the thumbscrew head of the Z Joint is on the other side of the LED flashlight. Also use dedicated supplied tool when tightening the Z Joint not to apply too much torque in accordance with Z Joint user manual.
- When using the Z Adapter, be sure to use pre-installed 「Spacer」 comes with the Z Adapter and the 「Strobe Light Holder Thumb Knob」 comes with this product. Before joint them together, make sure that black 「Rubber (O-ring)」 on the 「Strobe Light Holder Body」 and black 「Rubber (O-ring)」 on an arm base of compatible strobe is properly seated.

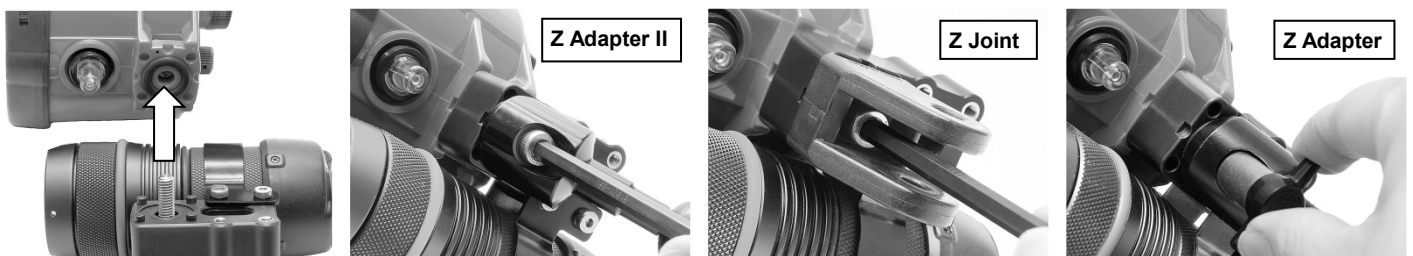

(continued)

When attaching LED flashlight only, use supplied「Strobe Light Holder M6 Screw」to fasten Z Adapter II/Z Joint/Z Adapter as shown in image right. Make sure that the protruded part of the「Strobe Light Holder Body」seats in groove of the「Strobe Light Holder M6 Screw」.

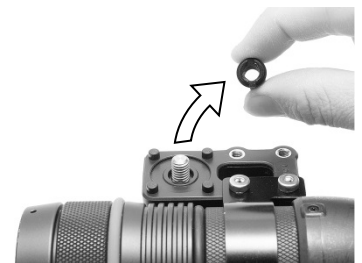

Installing on compatible Arm

Refer to respective user manual to attach on compatible “「YS Adapter」compatible arm” or “Arm II System”/“Float Arm System”.



Maintenance

- After dive clean with fresh water to remove salt etc. and dry the product completely in shaded and well ventilated area. DO NOT expose the product to flame or heat to prevent deformation or damage.
- DO NOT clean with organic solvent like alcohol, benzene or thinner and oil and fat containing/chemical material like rust inhibitor, lubricant, polish. DO NOT wash with any alkaline or chemical cleaning agents. This product is made from POM etc. which will dissolve or deform if put in contact with such materials.
- Remove this product from combined compatible lighting products when not in use more than one week to prevent possible deformation/damage on compatible product.
- Periodically grease up eight screw holes on the「Strobe Light Holder Body」and 「Strobe Light Holder M6 Screw」with supplied grease for LED flashlight to prevent anchoring of screws due to 「salt build-up」 or 「electrical corrosion」.

Storage

- Store out of direct sunlight in well-ventilated and dry area. Avoid storing near chemicals, high ozone, large temperature and humidity fluctuations and magnetic fields (TV sets etc.) to avoid deformation/damage, mold/rust or corrosion etc.
- Keep the flashlight out of reach of children. They may swallow small parts of this product. See a doctor immediately if a child swallow parts.

Handling

- Make sure to tighten screws properly not too tight or not too loose to prevent accidental separation/damage/loss of this product, strobe, LED flashlight, housing/protector etc.
- When carrying combined system with this product, always securely hold whole system instead holding this product or LED flashlight/strobe only and avoid excessive shock, vibration or load to prevent accidental separation/damage/loss of this product, LED flashlight/strobe, housing/protector etc.

Options

- Z Adapter II
Optional product to combine with this product to attach compatible INON LED flashlight (LF1000-S etc.) on “Arm II system” compatible ball-joint via 「Clamp III」.
- Z Joint
Optional product to combine with this product to attach compatible INON LED flashlight (LF1000-S etc.) on compatible “「YS Adapter」compatible arm”.



| INON Strobe Light Holder LF Specifications [*1] | |
|---|--|
| Model | Strobe Light Holder LF |
| Size | W: 122.3mm/4.8" x H: 42.4mm/1.7" x D: 52.7mm/2.1" |
| Weight [*2] | 65g/2.3oz (air) / approx. 35g/1.2oz (underwater) |
| Material/finishing | POM, corrosion resistant aluminum alloy/rigid alumite etc. |

*1 Subject to change without prior notice.

*2 Excluding 「Strobe Light Holder Cap Screw」/「Strobe Light Holder Thumb Knob Screw」/「Strobe Light Holder M6 Screw」

INON Inc.

2-18-9, Dai, Kamakura, Kanagawa 247-0061 JAPAN
E-mail support@inon.co.jp
Fax. +81(0)467-48-2178
URL http://www.inon.jp/

February 2015